



朗格塑机

LOG INJECTION MOLDING MACHINE

注塑工程解决商
PLASTIC INJECTION MOLDING PROJECT RESOLVER

LOG 朗格塑机
LOG MACHINE

宁波创基机械有限公司
NINGBO CHUANGJI MACHINERY CO.,LTD.

地址：浙江省余姚市泗门镇工业区块北大道泗门段18号
邮编：315400
电话：+86-574-62523811
传真：+86-574-62523801
服务电话：400 826 0110

ADD: Simen Industrial Area, yuyao, zhejiang Province, China
P.C:315400
TEL:+86-574-62523811
FAX:+86-574-62523801
SERVICE:400 826 0110

E-mail:loginmachine@logge.com.cn
www.logge.com.cn
www.log-machine.com



2017-1

LOG 朗格塑机
LOG MACHINE

简介 Summary

www.logge.com.cn www.log-machine.com

IOG[®]
朗格塑机
LOG MACHINE

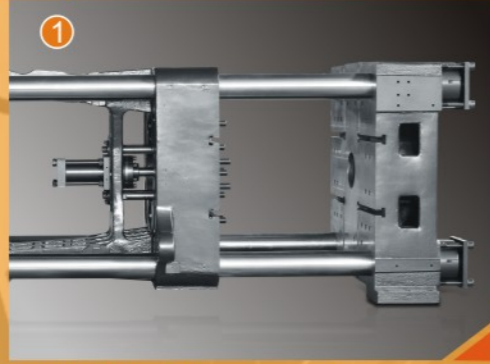

① 锁模部件 Clamping unit

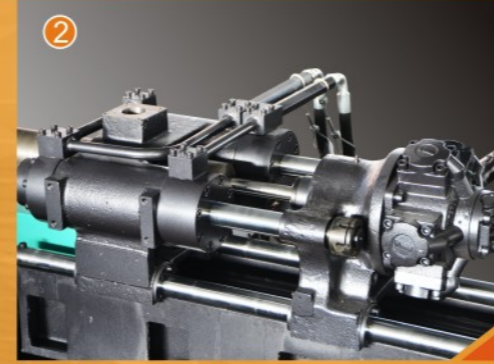

② 射胶部件 Injection unit

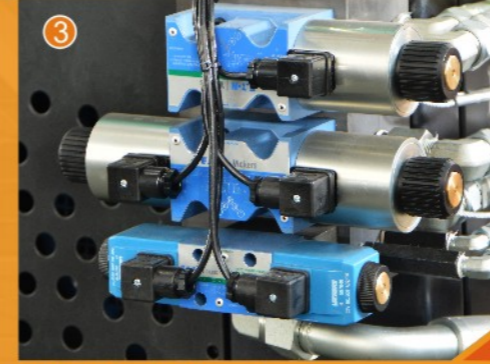

③ 液压部件 Hydraulic unit



④ 润滑部件 Lubricating unit



⑤ 电气部件 Electric parts

朗格塑机凭借多年的塑料机械制造经验，紧随市场需求，吸收国外先进的设计理念，采用高精度电脑控制器和高效节能的柱塞式比例变量泵完美结合，推出高精度变量泵A8、M6系列注射成型机。公司品牌理念是“量身定制，走差异化之路”基于模块化的工程设计思路，提供合理建议和完美的注塑解决方案，贴心服务，为客户量身定制各领域注塑机，应用于食品包装行业、民用产品行业、家电行业、电子行业、汽配行业、管件、玩具、礼品行业等。

With years of experiences on manufacturing injection molding machine, LOG MACHINE keeps up the market demand, adopting foreign advanced design concept, using high-precision controller and together with energy-efficient variable pump, launching high-precision Series A8 and M6 injection molding machine to the market. Log brand is customer oriented and based on a modular-design engineering ideas, providing reasonable advice and the perfect solution for injection projects. We offer qualified service and provide customer-needed injection molding machine in all different spheres of industry, including in the food packaging industry, household products industry, household appliances industry, electronic industry, auto industry, pipe fittings, toys, gifts and other industries.



锁模部件 Clamping Unit

www.logge.com.cn www.log-machine.com

LOG[®]
朗格塑机
LOG MACHINE



① 连体连杆 Conjoined toggle



② 高刚性模板 High-hardness platen



③ 中大机尾板法兰 Platen flange

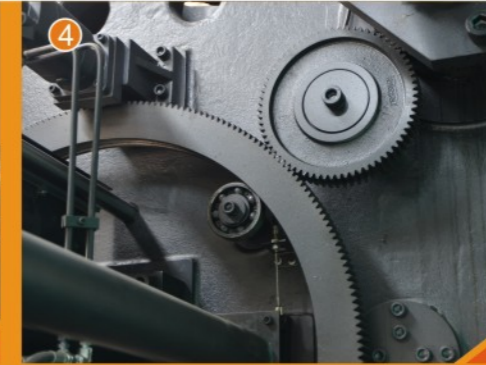

④ 齿轮调模 Gear-adjusting ring



⑤ 中大机石墨钢套 Graphite bush

1、前连杆采用连体结构，提高连杆的刚性，保证连杆加工尺寸的一致性。可以减小销轴与钢套的配合间隙。保证连杆机构的精度，提高连杆机构的使用寿命。

1. Toggle adopting the conjoined structure, improving the hardness of toggle, ensuring the uniform of toggle manufacture-size, minimizing the gap between pipe and pin, improve the accuracy and application life of toggle.

2、锁模头板采用箱式结构设计，模板厚度及内部强筋加厚，提高头板刚性，更加有效的减小拉杆受力时弯曲变形。

2. First clamping platen using the box-type structure design, thicken the thickness of platen, improving the hardness of platen, efficiently minimizing the deform caused by the force of tie bar.

3、中大机型独特的尾板法兰设计，尾板受力变形时，通过尾板法兰与拉杆的配合支撑，产生与尾板变形反向力矩，从而减小尾板变形。

3. Unique third-platen flange design, when the third-platen deforms by the pressure, by the support of flange and tie bar, a reverse torque will minimizing the deform of the third-platen.

4、采用齿轮调模结构重复精度高，调模力大，结构紧凑，方便客户在手动或自动调模精准调整容模量。

4. Adopting gear-adjusting ring with high-precision, large-scale transfer and compact structure to facilitate customer adjusting the mold thickness in manual or automatic.

5、中大机型锁模机构内的钢套采用新型结构，在钢套内合理布置石墨孔，提高钢套本身的润滑效果，提高钢套的耐磨性能，减少钢套加润滑油次数。

5. Steel bush in clamping unit adopts new structure, arrange rational holes of graphite to improve the effect of steel bush lubrication and the wear-resistance, reduces the usage of lubrication oil.

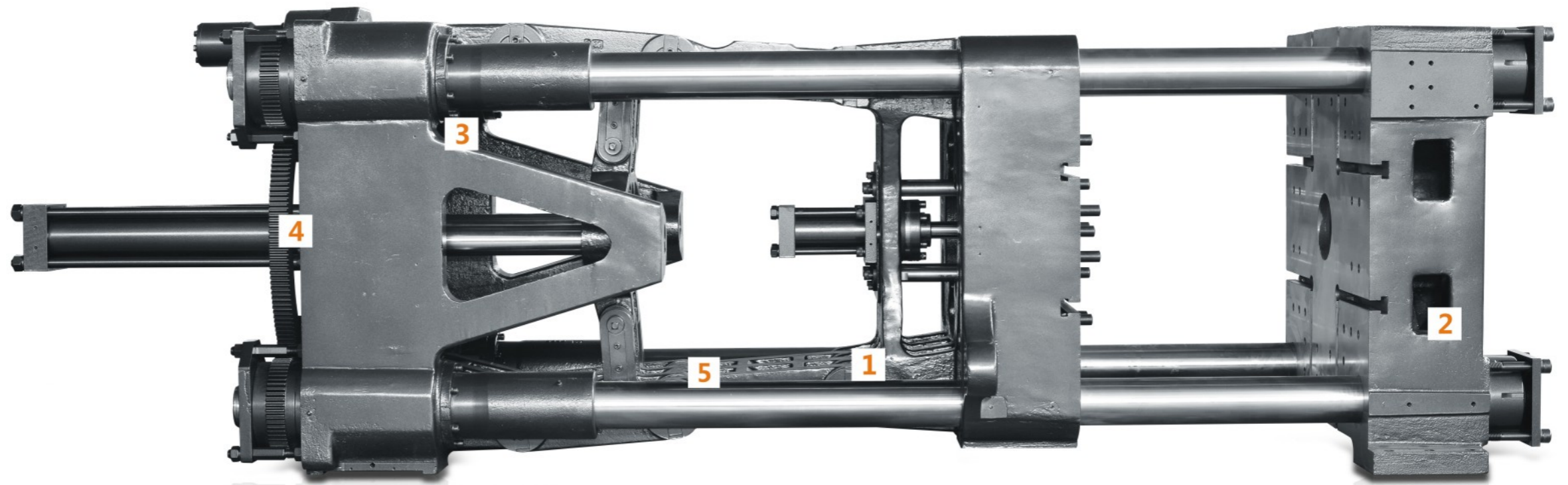

射胶部件 Injection Unit

www.logge.com.cn www.log-machine.com

LOG[®]
朗格塑机
LOG MACHINE

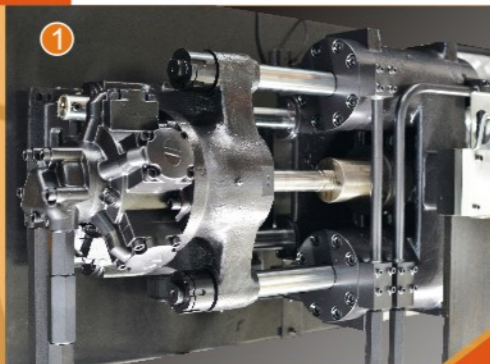

① 使用短捷有力的双缸注射
Sturdy double-cylinder injection



② 中大型机平衡双射移油缸设计
Balanced double-cylinder design



③ 无润滑石墨衬套
Graphite bush



④ 采用低摩擦密封件
Low-frictional seals



⑤ 可移动桥式射台底座
Moveable bridge-style rack

1、射胶部件采用双缸平衡设计，射胶压力更高，结构简单稳定。设计空间更短。故障率低。

1. Injection unit adopts double-cylinder design, more higher injection pressure, more simpler structure and lower malfunction rate.

2、加大射移油缸，大机型采用双射移油缸结构，有效的防止射嘴在机器高速运转下，由于机器震动等原因而产生漏胶现象。

2. Enlarged-cylinder, adopting two-cylinder design, effectively prevent the adhesive-material leaking phenomenon caused by the machine vibration or other reasons while the nozzle is under high-speed operation.

3、射胶导套采用石墨衬套，提高衬套耐磨性能，减少对衬套添加润滑频率，有效改善注射部件的清洁度。

3. Adopting graphite bush, improving the wear-resistance, reducing the frequency of using lubrication oil, effectively improve the cleanness of the injection part.

4、射胶油缸和射缸油缸采用低摩擦密封，提高注射响应速率及复杂工艺情况下提高射胶稳定性。

4. Injection cylinder adopts low-frictional seals, improving the response rate and improve the stability under the complicated processes of injection.

5、桥式射台座整体设计，适用于不同长径比的塑化部件。

5. Bridge-style design, for different L/D ratio plasticizing parts.

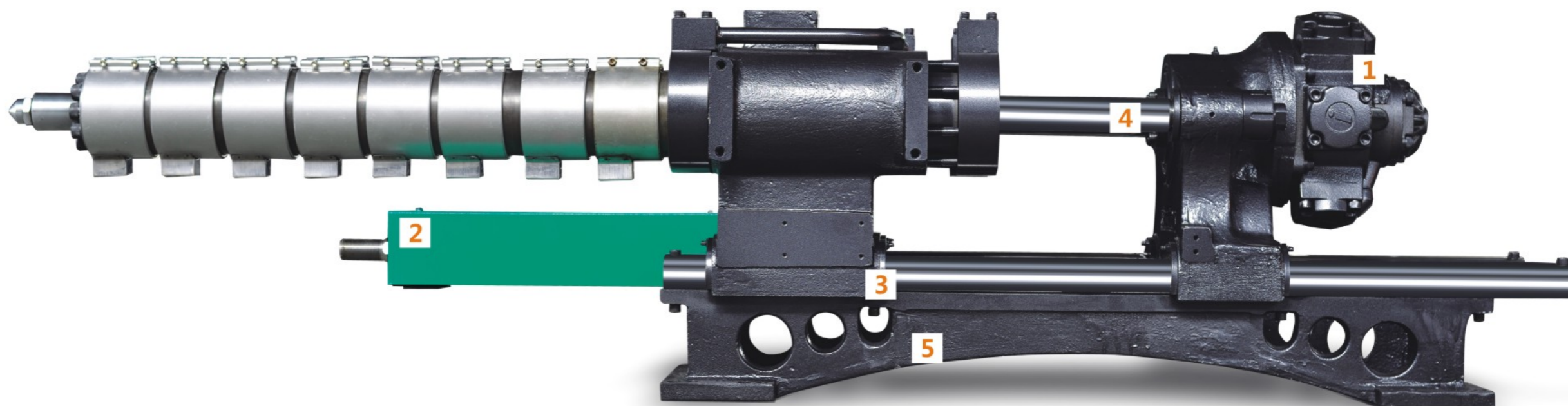

液压润滑部件 Hydraulic Parts

www.logge.com.cn www.log-machine.com

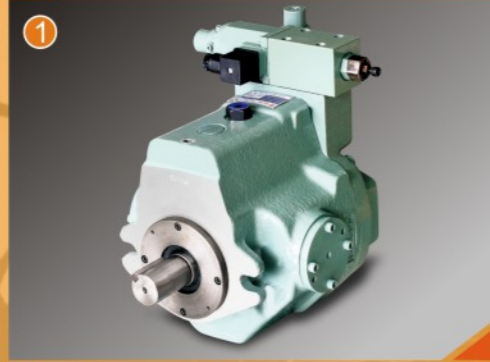

① 采用高压高效变量泵
High pressure and efficient variable pump



② 知名品牌液压件
Famous hydraulic parts



③ 高精度滤油装置
High precision filtering equipment



④ 高压软管保护装置
Oil pipe protection equipment



⑤ 高精度稀油润滑系统
High precision lubrication system

省电 Energy Saving

同等工作量的情况下，耗电量比普通定量泵省30%-70%。

As compared with fixed-pump system, it saves power by 30%-70%.

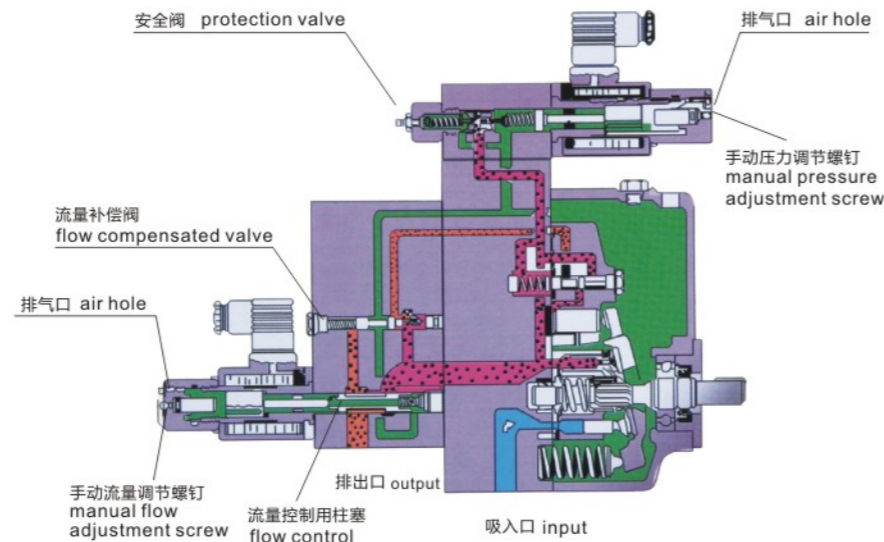

VDP Pump

High efficiency, energy-saving and high precise proportional pressure and flow variable displacement pump system make the out of the hydraulic system matching the required power for entire machine operation without loss of high pressure throttle and overflow energy. As compared with fixed pump, it saves power by 30%~60%. A motor with same power may be fitted with an oil pump of bigger displacement and thus accelerates the speed of machine. Besides, the low oil temperature will prolong the service life of sealing elements.

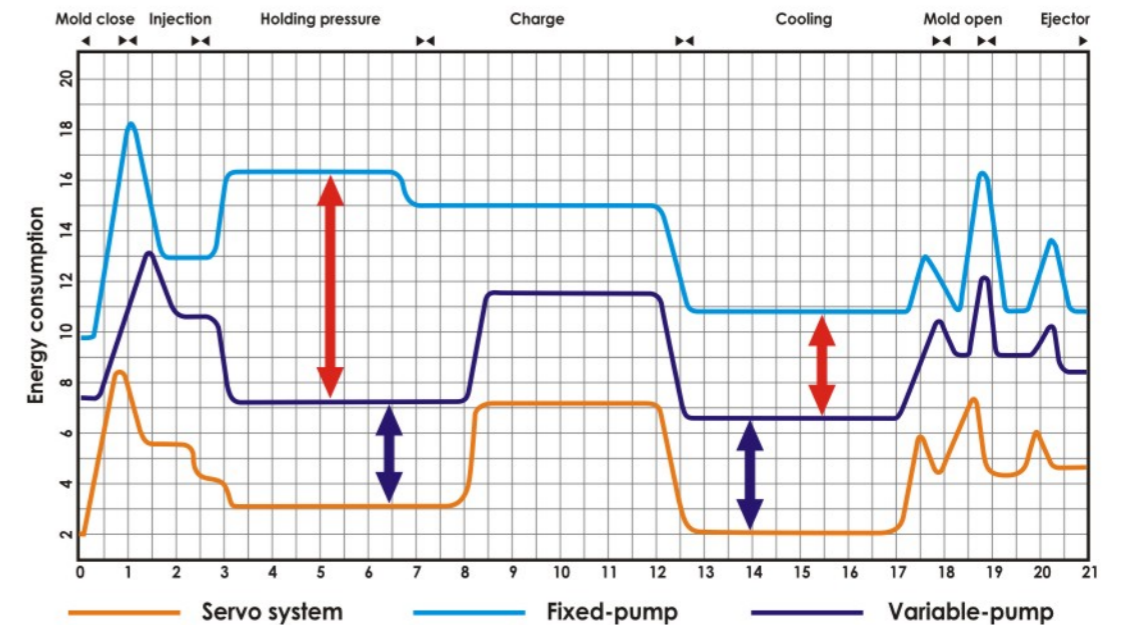

电气部件 Electric Parts

www.logge.com.cn www.log-machine.com



- ① 人性化的电脑界面操作简单，操作箱可旋转设计，操作方便。
1. Humanized computer interface operation, simple and convenient.
- ② 优化的电气设计，采用知名品牌注塑机专用电脑，响应速度快，控制可靠。
2. World famous computer brand professional for injection machine.
- ③ 设备生产过程中的资料完全保存，资料、清单、图形等不同展现方式完全符合实际应用需要。
3. Data will be saved during production process, displayed by list, diagram and other forms to meet the practical requirements.
- ④ 参数资料保护锁并带有断电自助保存功能，超容量的数据存储功能。
4. Huge storage and protect the data.



量身定制 Tailor Made

www.logge.com.cn www.log-machine.com

LOG[®]
朗格塑机
LOG MACHINE



1 PET瓶坯专用机
PET preform dedicated machine

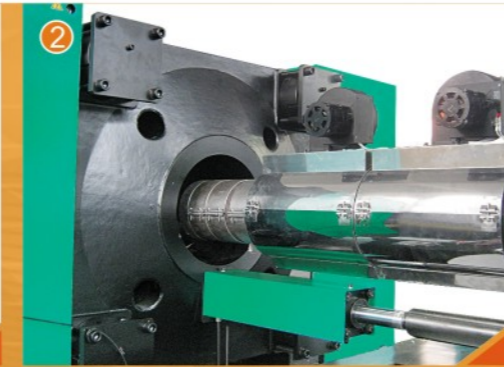

2 UPVC管接头专用机
UPVC Pipe dedicated machine



3 胶木专用机
Bakelite dedicated machine



4 高速成型机
High speed dedicated machine



5 BMC专用机
BMC dedicated machine

产品展示 Product display



螺杆 Screw

朗格可以为广大客户提供通用型螺杆，以满足多样化的注塑要求；更可以针对不同的塑料种类以及加工产品的特征，设计专用型的螺杆满足客户高品质，高精度的注塑需求。
如：UPVC、PMMA、PA、PC、CP、PPS、PET等专用螺杆。

LOG provides universal screws to diverse customers, in order to meet diverse needs of injection; also for different plastic types and suit the features of products, to design special screw to satisfy customer's demand, such as: UPVC/PMMA/PA/PC/CP/PPS/PET screw.

家电行业 appliances industry



汽配行业 automobile spare parts industry



粉末冶金 powder metallurgy



建筑材料 building materials

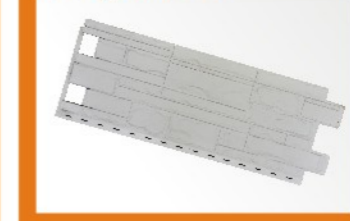

周转箱 pass box



食品包装 food packaging



管接头 pipe connecting



亚克力包装 acrylic packaging



喷头 shower nozzle



医疗包装 medical packaging



瓶坯 PET preform



扎带 cable ties



卫浴配件 bathroom accessory



电子配件 electronic components

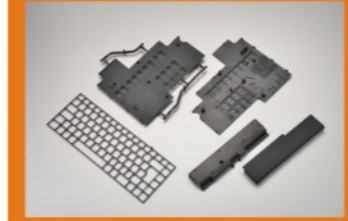

齿轮 gear



眼镜 glass



其他塑料制品 other plastic products

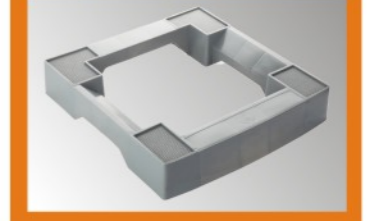

伺服系列 Servo Series

www.logge.com.cn www.log-machine.com

IOG[®]
朗格塑机
LOG MACHINE

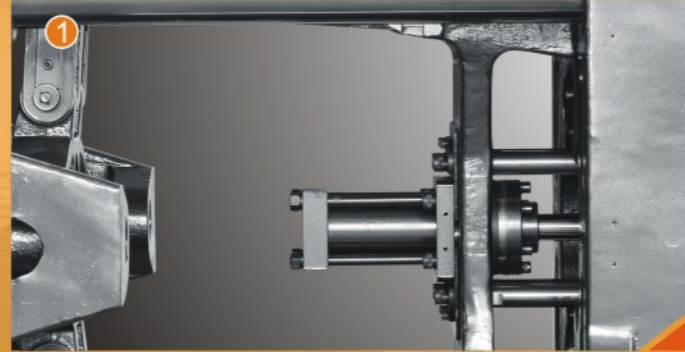

Enhance the hardness of platen and connectin toggle to meet production requirements under the conditions of high strength, high load and high precision



Removable bridge injection base, which is suitable for different L/D ratio plasticizing unit.



Adopt non-lubrication graphite injection bush, reduce the frequency of lubricating oil on injection bush improve the purity of the injection parts effectively.

1、整机外形按照人机工程学设计，机器外观及操作性能更具人性化。

1. Machine appearance is designed according to the ergonomics, which having more humanized appearance and operating performance.

2、经过对整机优化，开锁模速度更加快速、平稳，整机刚性得到大幅度提升。

2. Optimizing the whole machine, the clamping speed become more quickly, smoothly, and the toughness of whole machine is improved.

3、射台座采用整体铸造成型，适用于不同长径比塑化组件，使机器模块化组合更加方便。

3. Injection unit adopts the integral casting molding, which is suitable for different L/D ratio plasticizing components, making modularization-assembly more convenient.

4、加大射移油缸或双射移油缸的结构设计，有效的防止喷嘴漏胶现象。

4. Enlarged injection oil cylinder or big injection oil cylinder structure design, prevent the nozzle from leaking glue effectively.



全系列采用台湾工业自动化控制电脑。
Full series adopt Taiwan industrial automatic control computer.

伺服节能系统 Servo Saving Energy System

www.logge.com.cn www.log-machine.com

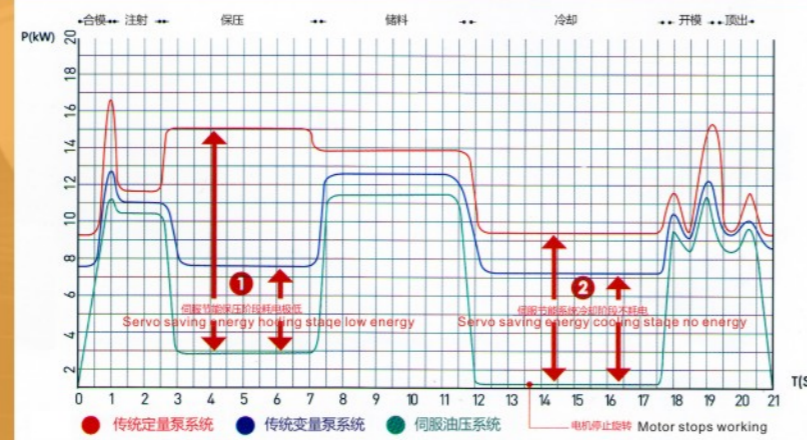

高效节能 Energy efficiency

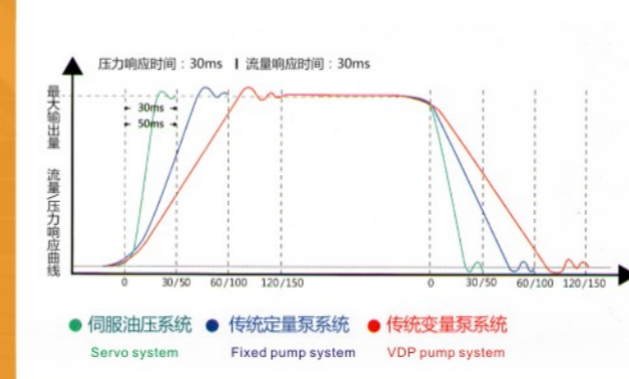

高响应 High response

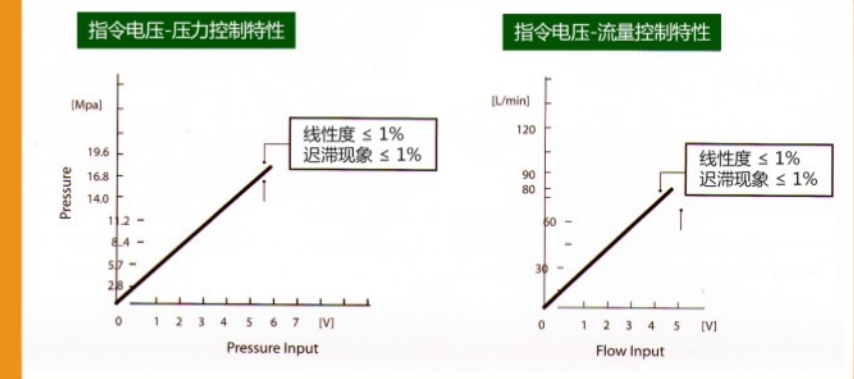

高重复精度 High repeat precision

伺服驱动特点 Servo Drive Feature

1、通过总线以高速通讯方式实现对实际压力、流量、驱动器输出电流，负载率等多个信号的实时监控。

High-speed communication via bus to realize the actual pressure, the flow of real-time monitoring of multiple signals, driver output current, load rate.

2、大中型注射器采用双泵或多泵合流方式，对伺服采用特殊控制技术，实现伺服油泵控制的完美同步，达到多台油泵合流的完美效果。

Medium-sized syringe of dual-pump or multiple-pump confluence way, using a special servo control technology to achieve the perfect synchronization control of servo and oil pump, to achieve the perfect confluence of multiple oil pumps.

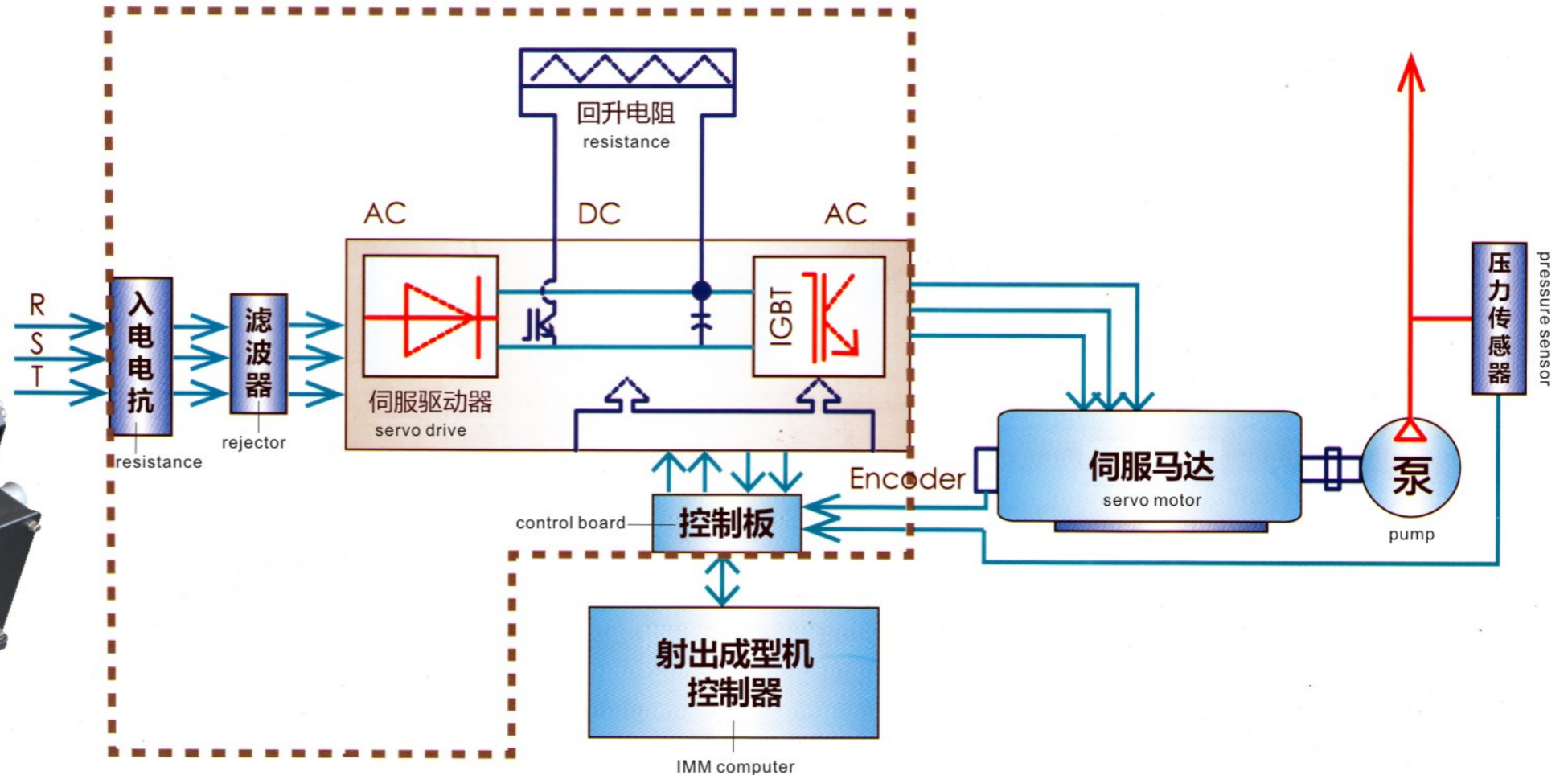
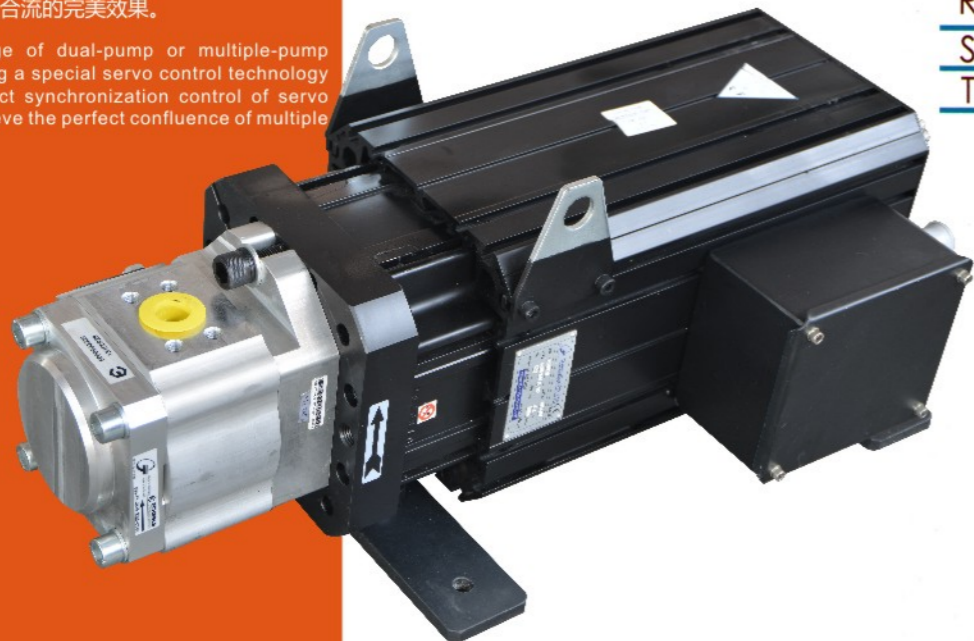

案例 Cases

www.logge.com.cn www.log-machine.com



1
快餐盒
Snack box



2
扎带
Cable ties



3
注射器专业医疗制品
Medical syringe



4
10英寸端末机框体外壳
10 inches frame shell

节能效果测试案例 Energy Saving Effect Test Cases

测试产品：快餐盒

Test product: snack box

原料 PP material pp
重量 21克 weight 21g
壁厚 0.43mm wall thickness:0.43mm
穴数 1出2 2 cavities

测试条件：

Test condition
三款机器 three sets machines
油泵排量相同； same oil pump displacement
参数设置相同； same settings
正常生产数小时； processing several hours
待油温稳定在40℃；oil temperature hold on 40 degrees
用电量监测。

经过实际测试，S8伺服节能注塑机在生产过程中，相比传统定量泵注塑机节能45.5%，最高节能可达80%。

After the actual test, in contrast to the traditional fixed pump system IMM, S8 servo system IMM saves energy by 45.5%, highest saving energy by 80%.

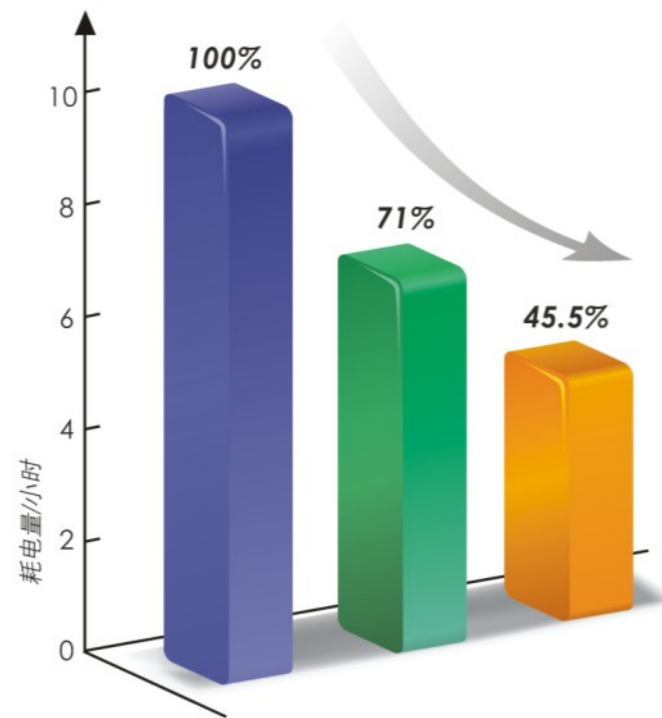

- 定量泵注塑机
fixed pump
- 变量泵注塑机
variable pump
- S8系列伺服节能注塑机
servo system

塑料成型机的取样分析 plastic machine sampling analysis		250T 定量泵注塑机 250T fixed pump IMM	250T 变量泵注塑机 250T variable pump IMM	250T 伺服节能注塑机 250T servo system IMM
测试时间	test time	2	2	2
油温	oil temperature	55	45	40
合模	close mold	1.8	1.8	1.6
开模	open mold	1.4	1.4	1.4
注射	injection	1.5	1.2	1
保压	holding pressure	0.5	0.4	0.2
熔胶	charging	2.2	2.2	1.8
成型周期	production cycle	7.4	7	6
总模数	total shot	973	1028	1200
每小时耗电量(kw/h)	power of one hour	12.3	10.6	8.8
一年耗电量(kw)	power of one year	66420	57420	47520

条件：每天运行18小时，每月运行25天，每年运行300天。

condition: running 18 hours per day, running 25 days per month, running 300 days per year.

参数表 Specifications

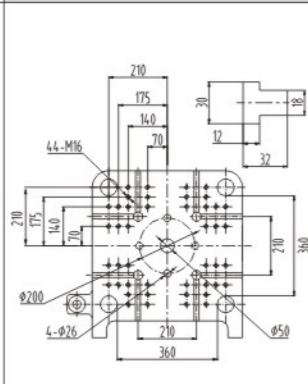
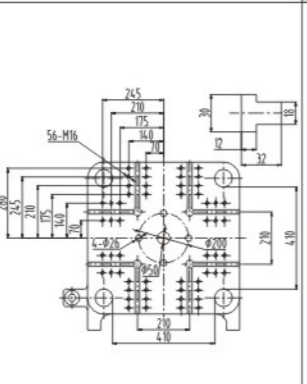
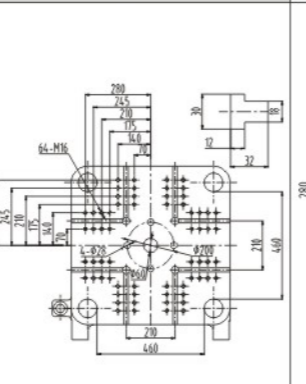
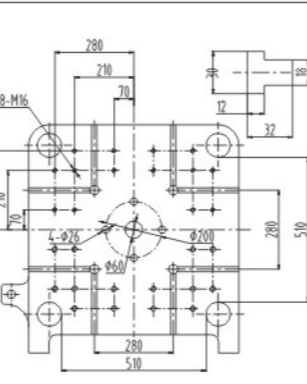
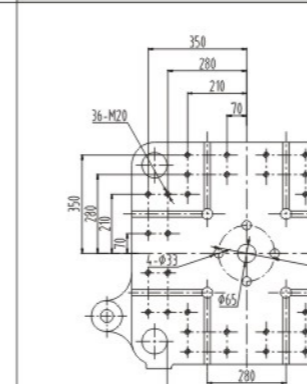
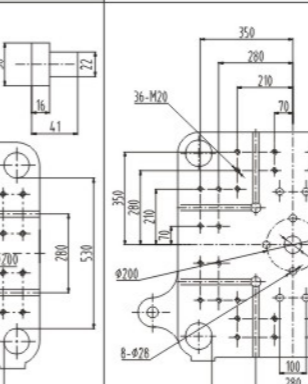
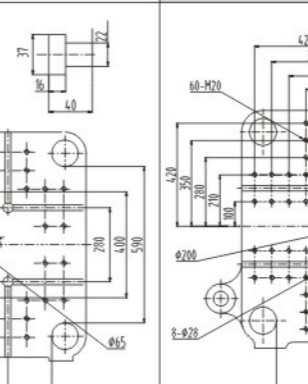
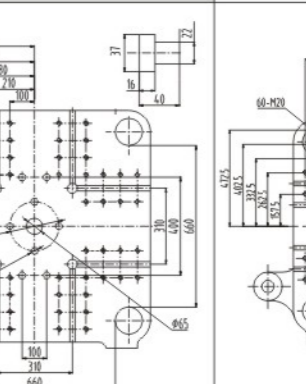
DESCRIPTION		LOG90			LOG130			LOG160			LOG210			LOG250			LOG300			LOG320			LOG400		
Injection		A	B	C	A	B	C	A	B	C	A	B	C	A	B	C	A	B	C	A	B	C	A	B	C
Screw diameter	mm	30	35	38	38	42	45	42	45	50	45	50	55	50	58	65	58	65	70	65	70	75	70	80	90
Screw L/D ratio	-	22:1	20:1	18:1	22:1	20:1	18:1	22:1	20:1	18:1	22:1	20:1	18:1	22:1	21:1	18.7:1	22:1	22:1	20:1	22:1	21:1	19.6:1	22:1	21:1	19:1
Injection volume	cm ³	113	154	181	215	263	302	277	318	392	381	470	569	510	687	863	740	929	1077	1062	1231	1414	1385	1810	2290
Shot weight(ps)	g	106	144	170	196	239	274	260	298	368	347	429	520	464	625	785	673	845	980	966	1120	1286	1260	1646	2084
	oz	4	5	6	7	8	10	9	11	13	12	15	18	16	22	27	24	30	34	34	39	45	44	58	73
Max injection rate	cm ³ /s	59	80	95	97	118	163	122	140	172	133	165	200	175	236	297	262	330	382	313	362	416	311	406	514
Plasticizing rate	kg/h	22	36	45	46	60	75	65	81	116	82	117	141	103	139	174	120	150	185	170	210 ¹	240	167	231	327
Injection pressure	mpa	243	179	152	193	158	138	190	166	135	217	176	145	224	166	132	190	151	130	175	152	133	206	158	125
Screw speed	r/min	0-180			0-180			0-200			0-200			0-180			0-150			0-170			0-135		
Clamping																									
Clamping force	kn	900			1300			1600			2100			2500			3000			3200			4000		
Opening stroke	mm	320			380			430			480			520			570			615			710		
Platen size	mm×mm	540×540			610×610			680×680			745×745			820×790			870×850			945×945			1060×1040		
Space between tie bars	mm×mm	360×360			410×410			460×460			510×510			560×530			610×590			660×660			730×710		
Mold thickness	mm	150-360			150-430			180-500			200-550			200-580			200-600			250-670			250-730		
Ejector stroke	mm	100			120			140			150			150			160			160			185		
Ejector force	kn	31			42			50			67			67			77			77			111		
General data																									
Max oil pressure	mpa	16			17.5			17.5			17.5			17.5			17.5			17.5			17.5		
Pump motor	kw	9			11			15			18.5			22			22			30			37		
Heating power	kw	6.5			7.7			12.6			13.1			16			18			21.5			32.3		
Heating zones	-	3+nozzle			4+nozzle			4+nozzle			4+nozzle			4+nozzle			5+nozzle			5+nozzle			5+nozzle		
Dry cycle time	sec	1.1			1.3			2			4.5			4.8			5			5			5.1		
Oil tank capacity	L	160			200			210			310			380			380			500			820		
Machine dimension	m×m×m	4.2×1.1×1.7			4.6×1.2×1.8			4.95×1.25×2.0			5.4×1.32×2.1			6.2×1.46×2.15			6.4×1.6×2.18			6.8×1.63×2.25			8.6×1.75×2.35		
Machine weight	kg	2800			3550			4720			6500			8000			9100			12500			14970		
Mold plate Size	mm																								

参数表 Specifications

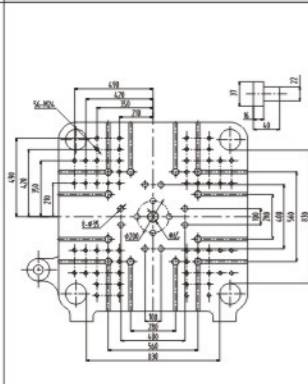
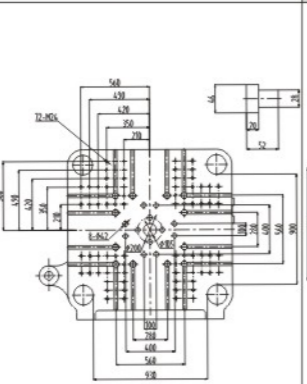
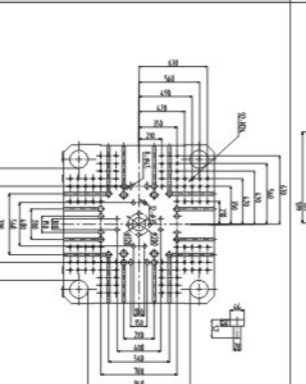
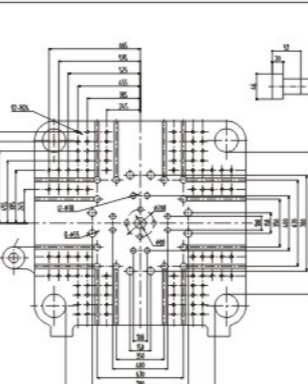
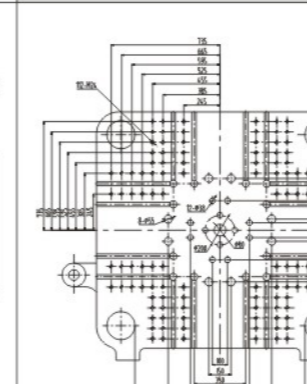
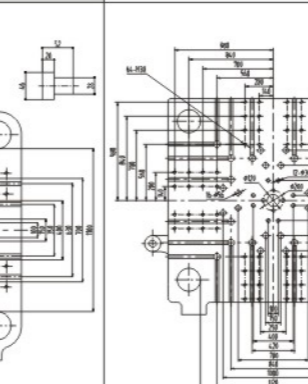
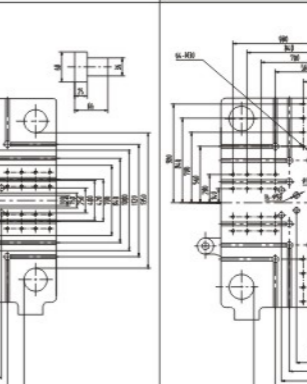
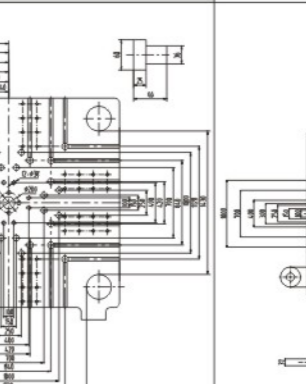
DESCRIPTION		LOG500			LOG650			LOG800			LOG900				LOG1100				LOG1500				LOG1800			LOG2200				
Injection		A	B	C	A	B	C	A	B	C	A	B	C	D	A	B	C	D	A	B	C	D	A	B	C	A	B	C	D	
Screw diameter	mm	75	85	95	80	90	100	85	95	105	90	100	110	120	100	110	120	130	110	120	130	140	130	140	150	150	160	170	185	
Screw L/D ratio	-	22:1	21:1	18.7:1	22:1	21:1	19:1	24.5:1	22:1	20:1	22:1	22:1	20:1	18.3:1	22:1	22:1	20.2:1	18.6:1	26.2:1	24:1	22.2:1	20.6:1	24:1	22.3:1	20.8:1	23.5:1	22:1	20.7:1	22:1	
Injection volume	cm ³	1590	2042	2550	2160	2734	3376	2558	3195	3903	3179	3925	4750	5652	4123	4989	5938	6968	5464	6503	7632	8851	8495	9852	11310	13183	15000	16933	24192	
Shot weight(ps)	g	1494	1919	2397	1966	2488	3072	2327	2907	3552	2893	3571	4321	5143	3751	4540	5403	6340	4972	5918	6945	8054	7730	8965	10292	12043	13700	15468	22075	
	oz	52	67	84	67	87	108	81	101	124	103	127	153	182	133	161	191	225	176	210	246	285	274	318	365	422	480	542	774	
Max injection rate	cm ³ /s	357	459	573	420	531	656	515	610	700	540	666	806	960	702	850	1010	1186	782	931	1092	1267	1128	1308	1502	1335	1519	1715	1700	
Plasticizing rate	kg/h	188	256	338	254	340	442	272	355	472	291	378	503	600	378	503	600	767	380	453	532	578	500	543	594	43.97	50.03	56.47	61.94	
Injection pressure	mpa	204	159	127	215	170	138	218	175	143	227	184	152	128	220	182	153	130	200	168	143	123	164	142	123	186	164	145	153	
Screw speed	r/min	0-125			0-140			0-130			0-120				0-120				0-95				0-80			0-80	0-80	0-80	0-60	
Clamping																														
Clamping force	kn	5000			6500			8000			9000				11000				15000				18000			22000				
Opening stroke	mm	820			920			1000			1050				1150				1500				1610			1850				
Platen size	mm*mm	1180x1180			1320x1290			1450x1385			1530x1530				1650x1650				2090x2050				2230x2100			2450x2300				
Space between tie bars	mm*mm	830x830			930x900			1030x940			1080x1030				1150x1100				1450x1350				1550x1430			1750x1600				
Mold thickness	mm	300-820			350-910			400-1000			400-1100				450-1200				700-1400				700-1500			700-1700				
Ejector stroke	mm	210			265			300			300				350				350				400			420				
Ejector force	kn	111			182			200			270				270				318				318			500				
General data																														
Max oil pressure	mpa	17.5			17.5			16			17.5				17.5				16				16			17.5				
Pump motor	kw	22+22			22+30			30+37			37+37				45+45				37+37+37				37+37+30+30			55+55+55				
Heating power	kw	35.4			38.3			49			58.45				68.48				85.55				95.05			100				135
Heating zones	-	5+nozzle			6+nozzle			6+nozzle			6+nozzle				6+nozzle				6+nozzle				6+nozzle			7+nozzle				
Dry cycle time	sec	5.2			6			7.0			8				10				14				18			18				
Oil tank capacity	L	1150			1500			1500			1900				2300				2900				3000			4100				4100
Machine dimension	m*m*m	9.25x1.85x2.0			9.6x1.9x2.3			10.6x2.6x2.7			11x2.4x3.1				12.5x2.8x3.5				13.9x3.2x4.7				14.2x3.4x5.1			17.5x4.2x3.7				18.5x4.8x4.3
Machine weight	kg	20500			28000			36000			48000				60000				82000				105000			136000				140000
Mold plate Size	mm																													

参数表 Specifications

机器尺寸 Machine Size

Pet preform dedicated machine specifications

DESCRIPTION	MODEL	LOG160	LOG210	LOG250	LOG300	LOG320	LOG400	LOG500	LOG650
Injection									
Screw diameter	mm	50	55	65	70	75	90	95	100
Screw L/D ratio	-	23:1	23:1	23:1	24:1	24:1	24:1	24:1	24:1
Injection volume	cm ³	392	569	863	1077	1414	2290	2550	3376
Shot weight(pet)	g	478	676	1020	1274	1670	2710	3115	3990
	oz	12.9	18.1	27.4	34.2	44.9	72.8	83.9	107.5
Max injection rate	cm ³ /s	172.8	200	297	382	416	514	573	656
Plasticizing rate	kg/h	152	183	227	241	312	425	439	575
Injection pressure	mpa	135	145	132	130	133	125	127	138
Screw stroke	mm	200	240	260	300	320	360	360	430
Screw speed	r/min	0-180	0-200	0-180	0-150	0-150	0-135	0-150	0-125
Clamping									
Clamping force	kn	1600	2100	2500	3000	3200	4000	5000	6500
Opening stroke	mn	430	480	520	570	615	670	780	920
Platen size	mm×mm	680x680	745x745	820x790	870x850	945x945	1060x1040	1180x1180	1320x1290
Space between tie bars	mm×mm	460x460	510x510	560x530	610x590	660x660	730x710	830x830	930x900
Mold thickness	mm	180-500	200-550	200-580	200-600	250-670	250-730	300-820	350-910
Max.daylight	mm	930	1030	1100	1170	1285	1400	1600	1830
Ejector stroke	mm	140	150	150	160	160	185	210	265
Ejector force	kn	50	67	67	77	77	111	111	182
General data									
Max oil pressure	mpa	17.5	17.5	17.5	17.5	17.5	17.5	17.5	17.5
Pump motor	kw	15	18.5	22	30	30	37	45	55
Heating power	kw	17.2	17.4	20.4	22.5	26.3	36.1	43.2	47.3
Heating zones	-	4+nozzle	4+nozzle	5+nozzle	5+nozzle	5+nozzle	5+nozzle	5+nozzle	6+nozzle
Dry cycle time	sec	2	4.5	4.8	5	5	5.1	5.2	6
Oil tank capacity	L	210	310	380	380	500	820	1150	1500
Machine dimension	m×m×m	5.5x1.25x2.0	5.7x1.32x2.1	6.8x1.6x2.15	6.8x1.5x2.18	7.1x1.58x2.25	7.9x1.75x2.41	8.6x1.85x2.41	9.6x1.9x2.3
Machine weight	kg	4720	6500	8000	9100	12500	14970	20500	36000

High-speed injection machine specifications

DESCRIPTION	MODEL	LOG130	LOG160	LOG210	LOG250	LOG300	LOG320
Injection							
Screw diameter	mm	38	45	50	50	50	65
Screw L/D ratio	-	24:1	24:1	24:1	24:1	24:1	24:1
Injection volume	cm ³	181	302	392	392	392	863
Shot weight(pp)	g	149	240	322.4	322.4	322.4	687.6
Max injection rate	cm ³ /s	136.8	281	297.2	356.6	356.6	513.2
Plasticizing rate(pp)	kg/h	49	90	139	152.8	152.8	183.6
Injection pressure	mpa	152	138	135	135	135	132
Screw speed	r/min	0—290	0—276	0—409	0—495	0—495	0—364
Clamping							
Clamping force	kn	1300	1600	2100	2500	3000	3200
Opening stroke	mn	380	430	480	520	570	615
Platen size	mm×mm	610x610	680x680	745x745	820x790	870x850	945x945
Space between tie bars	mm×mm	410x410	460x460	510x510	560x530	610x590	660x660
Mold thickness	mm	150-430	180-500	200-550	200-580	200-600	250-670
Ejector stroke	mm	120	140	150	150	160	160
Ejector force	kn	42	50	67	67	77	77
General data							
Max oil pressure	mpa	17.5	17.5	17.5	17.5	17.5	17.5
Pump motor	kw	15	22	30	37	37	22+22
Heating power	kw	8.1	9.6	15.7	15.7	15.7	20
Heating zones	-	3+1	4+1	4+1	4+1	4+1	4+1
Dry cycle time	sec	4.0	4.0	4.5	4.5	4.5	5.0
Oil tank capacity	L	210	380	500	820	820	1150
Machine dimension	m×m×m	4.6x1.2x1.8	4.95x1.25x2.0	5.4x1.32x2.1	6.2x1.46x2.15	6.4x1.63x2.25	8.6x1.85x2.35
Machine weight	kg	3450	4600	6350	7820	8900	12250

For constant improvements upon research, our company reserves the right to change the design parameters and configurations. No notice will be given for any change, the chinese version shall prevail in all interpretations.

型号	A	B	C	D	E
LOG90-A8	1500	4000	4200	1700	1100
LOG110-A8	1550	4000	4200	1750	1150
LOG130-A8	1600	4200	4600	1800	1200
LOG160-A8	1700	4550	4950	2000	1250
LOG210-A8	1800	5250	5400	2030	1320
LOG250-A8	1850	5870	6200	2150	1460
LOG300-A8	1900	6200	6400	2160	1620
LOG320-A8	1980	6560	6800	2225	1630
LOG400-A8	2030	7600	8600	2350	1750
LOG500-A8	2070	8200	9200	2410	1850
LOG650-A8	2180	9300	9600	2250	1880
LOG800-A8	2270	10200	10600	2900	2300
LOG900-A8	2385	10700	11000	3100	2400
LOG1100-A8	2850	12000	12500	3500	2800
LOG1300-A8	2800	12800	13500	4500	2900
LOG1500-A8	2800	12800	13900	4700	3200
LOG1800-A8	2950	13500	14200	5100	3400
LOG2200-A8	3525	16800	17800	5300	3500
LOG2800-A8	3620	17030	17400	5700	3920
LOG3300-A8	4300	2100	2250	5700	4500
LOG4000-A8	4500	2200	2350	5700	4700

型号	a	b	c	d	e	f	g
LOG90-A8	320	150-360	10	100H8	30	250	3
LOG110-A8	350	150-380	10	100H8	30	250	3
LOG130-A8	380	150-430	10	100H8	30	250	3
LOG160-A8	430	180-500	10	100H8	30	250	3
LOG210-A8	480	200-550	10	120H8	30	325	3.5
LOG250-A8	550	200-580	10	120H8	30	325	3.5
LOG300-A8	570	200-600	10	150H8	30	360	3.5
LOG320-A8	615	250-670	10	150H8	30	360	3.5
LOG400-A8	660	250-730	10	150H8	30	450	4
LOG500-A8	780	300-820	10	150H8	30	450	5
LOG650-A8	920	350-910	10	170H8	30	550	5
LOG800-A8	1000	400-1000	10	250H8	50	690	5
LOG900-A8	1050	400-1100	10	250H8	50	690	5
LOG1100-A8	1150	450-1200	10	250H8	50	690	6.5
LOG1300-A8	1300	550-1350	10	250H8	50	710	6.5
LOG1500-A8	1500	700-1400	10	250H8	50	710	6.5
LOG1800-A8	1600	700-1500	10	315H8	50	740	6.5
LOG2200-A8	1850	700-1700	10	315H8	50	950	7
LOG2800-A8	2050	1000-1900	20	315H8	50	1030	10
LOG3300-A8	2160	1000-2200	20	315H8	50	1170	10
LOG4000-A8	2255	1000-2200	20	315H8	50	1300	10

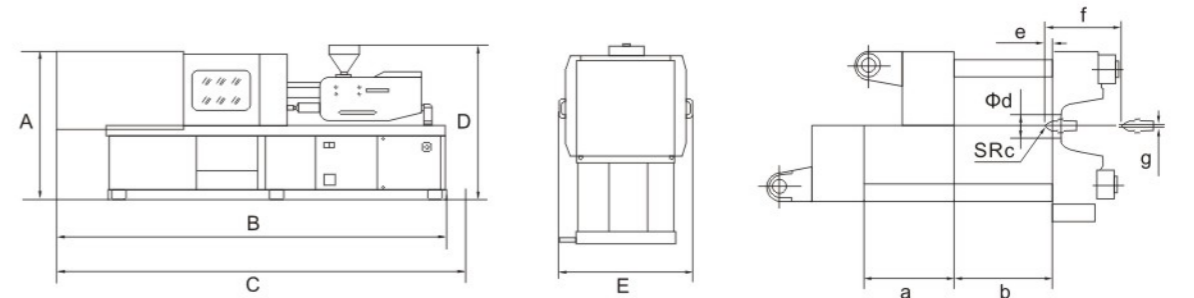

A8/M6系列配置表 A8/M6 System Configuration Table

注射部件 Injection unit	
双缸注射系统 Double cylinder injection system	
抗疲劳、抗腐蚀螺杆料筒 Antifatigue, anti-corrosive screw and barrel	
注射、保压、储料、速度、压力时间多段控制 Injection, pressure-holding, storing, speed, pressure time multistage control	
位置或时间注射转保压控制 Turn injection of location or time to pressure-holding control	
注射位置电子尺控制 Injection location electronic ruler control	
防止螺杆冷启动功能 To prevent the screw cold start function	
低速大扭矩油马达预塑 Low speed high torque hydraulic motor preplastication	
料筒温度闭环控制 Barrel temperature closed loop control	
喷嘴对中调节装置 The nozzle centre adjusting device	
螺杆测速装置 Screw speed detection device	
不锈钢料斗 Stainless steel hopper	
料筒下料口冷却 Barrel feed opening cooling	

电控系统 Electronic control system	
8" LCD彩色显示屏 (A8) / 7" LCD彩色显示屏 (M6) 8" LCD color led screen(A8)/ 7" LCD color led screen(M6)	
200组电脑内存模具记忆功能 200 groups computer internal storage mould memory function	
温度偏差显示, 热电偶断路报警功能 Temperature deviation display, thermocouple circuit alarm function	
系统硬件I/O检测功能 system hardware I/O detection function	
预留打印机接口、软驱接口 Reserve a printer interface, floppy Port	
电机安全保护功能 Electric motor safety protection function	
紧急停止保护装置 Emergency stop protection function	

随机附件 Spare parts	
可调防震垫脚 Adjustable Shockproof foot-pad	
易损件 Quick-wear part	
常用工具 Frequently-used tools	
机器说明书 Machine manual	

选配装置 Optional Devices	
相近锁模单元和注射单元互换 Exchange neighbouring clamping unit and injection unit	
特殊原料专用塑化件 Special raw material plasticizing pieces	
特殊材质塑化件 Special texture Plasticizing pieces	
蓄能器辅助快速注射装置 Accumulator auxiliary rapid injection device	
液压抽芯装置 Hydraulic pressure core-pulling device	
公母模吹气装置 Male and female air blowing device	
玻管分水器 Glass pipe water segregator	
加长喷嘴 Extended-nozzle	

锁模部件 Clamping unit	
斜排五铰链内卷式双曲合模机构 Diagonal row within five hinge type hyperbolic clamping mechanism	
开关模电子尺控制 Open-close mould electronic ruler control	
机械安全机构 Mechanical safety mechanism	
多段开合模压力速度位置控制 Multistage open-close mould pressure speed location control	
快速差动合模系统 Rapid differential clamping system	
自动调模功能 Automatic mold-adjustment function	
低压模保功能 Low pressure mold protect function	
箱式模板: T型槽 (A8) / 普通螺纹孔 (M6) Box template: T-slot(A8)/ Normal threaded hole(M6)	
自动集中润滑系统 Automatic centralized lubrication system	

液压系统 Hydraulic system	
油研柱塞式变量泵 (A8) / 普什柱塞式变量泵 (M6) YUKEN plunger variable pump(A8) / PUSH plunger variable pump(M6)	油温检测及报警功能 Oil temperature detection and alarm device
吸油过滤系统 Suction filter system	旁路过滤器 Bypass strainer

主要元器件品牌 MAIN COMPONENTS BRAND



因设计更新, 以上参数如有更改, 恕不通知
We reserve the right to change the specification without prior notice

S8/S6系列配置表 S8/S6 System Configuration Table

注射部件 Injection unit	
双缸注射系统 Double cylinder injection system	
抗疲劳、抗腐蚀螺杆料筒 Antifatigue, anti-corrosive screw and barrel	
注射、保压、储料、速度、压力时间多段控制 Injection, pressure-holding, storing, speed, pressure time multistage control	
位置或时间注射转保压控制 Turn injection of location or time to pressure-holding control	
注射位置电子尺控制 Injection location electronic ruler control	
防止螺杆冷启动功能 To prevent the screw cold start function	
低速大扭矩油马达预塑 Low speed high torque hydraulic motor preplastication	
料筒温度闭环控制 Barrel temperature closed loop control	
喷嘴对中调节装置 The nozzle centre adjusting device	
螺杆测速装置 Screw speed detection device	
不锈钢料斗 Stainless steel hopper	
料筒下料口冷却 Barrel feed opening cooling	

电控系统 Electronic control system	
8" LCD彩色显示屏 (A8) / 7" LCD彩色显示屏 (M6) 8" LCD color led screen(A8)/ 7" LCD color led screen(M6)	
200组电脑内存模具记忆功能 200 groups computer internal storage mould memory function	
温度偏差显示, 热电偶断路报警功能 Temperature deviation display, thermocouple circuit alarm function	
系统硬件I/O检测功能 system hardware I/O detection function	
预留打印机接口、软驱接口 Reserve a printer interface, floppy Port	
电机安全保护功能 Electric motor safety protection function	
紧急停止保护装置 Emergency stop protection function	

随机附件 Spare parts	
可调防震垫脚 Adjustable Shockproof foot-pad	
易损件 Quick-wear part	
常用工具 Frequently-used tools	
机器说明书 Machine manual	

选配装置 Optional Devices	
相近锁模单元和注射单元互换 Exchange neighbouring clamping unit and injection unit	
特殊原料专用塑化件 Special raw material plasticizing pieces	
特殊材质塑化件 Special texture Plasticizing pieces	
蓄能器辅助快速注射装置 Accumulator auxiliary rapid injection device	
液压抽芯装置 Hydraulic pressure core-pulling device	
公母模吹气装置 Male and female air blowing device	
玻管分水器 Glass pipe water segregator	
加长喷嘴 Extended-nozzle	

锁模部件 Clamping unit	
斜排五铰链内卷式双曲合模机构 Diagonal row within five hinge type hyperbolic clamping mechanism	
开关模电子尺控制 Open-close mould electronic ruler control	
机械安全机构 Mechanical safety mechanism	
多段开合模压力速度位置控制 Multistage open-close mould pressure speed location control	
快速差动合模系统 Rapid differential clamping system	
自动调模功能 Automatic mold-adjustment function	
低压模保功能 Low pressure mold protect function	
箱式模板: T型槽 (A8) / 普通螺纹孔 (M6) Box template: T-slot(A8)/ Normal threaded hole(M6)	
自动集中润滑系统 Automatic centralized lubrication system	

液压系统 Hydraulic system	
高精密齿轮泵 High precision gear pump	油温检测及报警功能 Oil temperature detection and alarm device
吸油过滤系统 Suction filter system	旁路过滤器 Bypass strainer

主要元器件品牌 MAIN COMPONENTS BRAND



因设计更新, 以上参数如有更改, 恕不通知
We reserve the right to change the specification without prior notice